



Part Number : [1300130573](#)

Product Description : Mini-Change A-Size Receptacle, 6 Poles, 1/2" - 14 NPT Threads, Female (Straight) to 16 AWG Leads, 0.91m (3.0') Length

Series Number : 130013

Status : Active

Product Category : Circular Industrial Connectors

Engineering Number : 1R6004A20F030

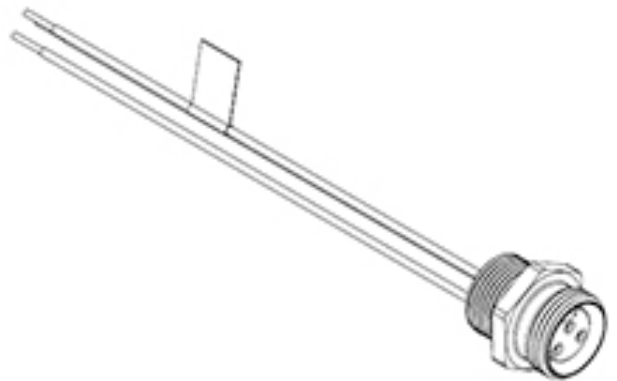

Documents & Resources

Drawings

[Drawing 1300130573_sd.pdf](#)

Product Environment Compliance

Compliance

GADSL/IMDS	Not Relevant
China RoHS	Not Reviewed per SJ/T 11365-2006
EU ELV	Not Relevant
Low-Halogen Status	Not Reviewed per IEC 61249-2-21
REACH SVHC	Not Reviewed per D(2023)3788-DC (14 Jun 2023)
EU RoHS	Not Reviewed per EU 2015/863

Multiple Part Product Compliance Statements

- Eu RoHS
- REACH SVHC
- Low-Halogen

Multiple Part Industry Compliance Documents

- IPC 1752A Class C
- IPC 1752A Class D
- Molex Product Compliance Declaration
- IEC-62474
- chemSHERPA (xml)

Part Details

General

Status	Active
Category	Circular Industrial Connectors
Series	130013
Description	Mini-Change A-Size Receptacle, 6 Poles, 1/2" - 14 NPT Threads, Female (Straight) to 16 AWG Leads, 0.91m (3.0') Length
IP Rating	IP67
NEMA Rating	NEMA 6
Product Family	Brad Mini-Change Connectors
Product Name	Mini-Change
Type	Single Ended (pigtail)
UPC	78678843960

Agency

CSA	LR6837
UL	E152210

Electrical

Current - Maximum per Contact	8.0A
Voltage - Maximum	600V AC/DC

Physical

Coupling Type	External Thread
Gender	Female
Keyway	Single
Length	1.83m
Material - Component	Zinc Die-Cast with Black Epoxy
Mounting Thread Size	1/2" - 14 NPT
Orientation	Straight
Panel Mount	N/A
Poles	6

Temperature Range - Operating	-20° to +105°C
Wire/Cable Type	N/A
Wire Size (AWG)	16

This document was generated on Oct 11, 2023