

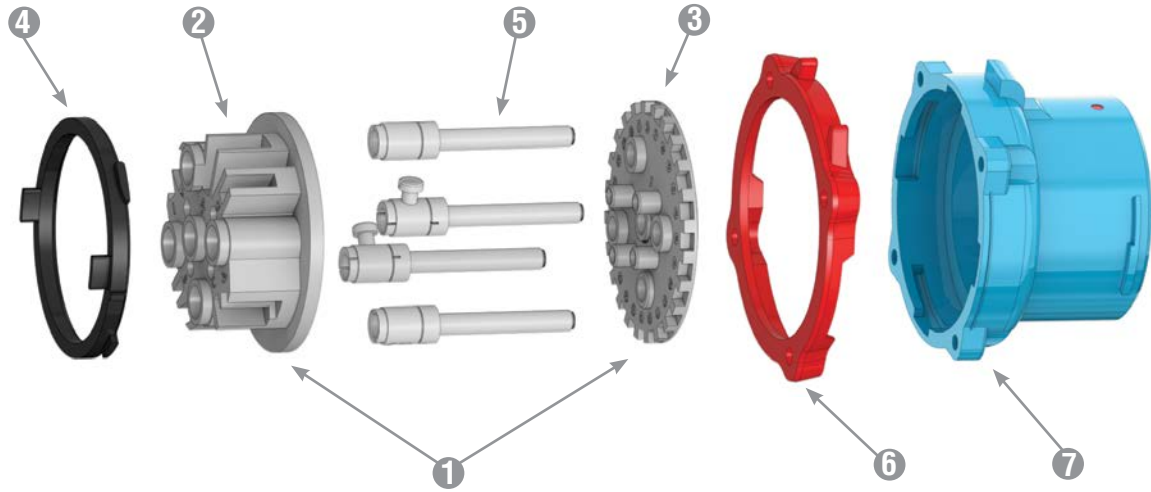







# Spare Parts Male Configuration



	DS20 POLY	DS30 POLY	DS60 POLY	DS60 METAL	DS100C POLY	DS100C METAL	DS100 POLY	DS100 METAL	DS200 METAL
1 = Plug Interior***	31-1A010*	31-3A010*	31-6A010*	31-6A010*	31-6A010-C*	31-6A010-C*	61-9A010*	69-9A010*	39-2A010*
1 = Plug Interior w/Ground Contacts***	-	-	-	39-6A110*	-	39-6A110-C*	-	69-9A110*	39-2A110*
1 = Plug Interior with 2 Pilots <sup>+</sup>	31-1A310-972*	31-3A310-972*	31-6A310-972*	31-6A310-972*	31-6A310-C-972*	31-6A310-C-972*	61-9A310-262*	61-9A310-262*	39-2A310-172*
2 = Interior Bottom***	31-1A010-B	31-3A010-B	31-6A010-B	31-6A010-B	31-6A010-C-B	31-6A010-C-B	61-9A551	69-9A551	39-2A010-B
3 = Interior Top***	31-1A010-T*	31-3A010-T*	31-6A010-T*	31-6A010-T*	31-6A010-C-T*	31-6A010-C-T*	61-9A010-T*	69-9A010-T*	39-2A010-T*
4 = Polyester Locking Ring	31-1A583	31-3A583	31-6A583	-	31-6A583	-	31-9A583	-	-
4 = Metal Locking Ring	-	-	-	39-6A583	-	39-6A583	-	39-9A583	39-2A583
5 = Plug Phase Contact (If no aux. contacts)	31-1A011-380	31-3A011-380	31-6A011	31-6A011	31-6A011-C	31-6A011-C	61-9A011	61-9A011	39-2A011
5 = Plug Phase Contact (If plug has aux. contacts)	31-1A011	31-3A011-380	31-6A011	31-6A011	31-6A011-C	31-6A011-C	61-9A011	61-9A011	39-2A011
5 = Plug Ground Contact	31-1A019	31-3A019	31-6A019	39-6A019	31-6A019-C	39-6A019-C	61-9A019	69-9A019	39-2A019
6 = Color-Coded Voltage Gasket	 31-1AB26	31-3AB26	31-6AB26	31-6AB26	31-6AB26	31-6AB26	31-9AB26	31-9AB26	39-2AB26
	 31-1AC26	31-3AC26	31-6AC26	31-6AC26	31-6AC26	31-6AC26	31-9AC26	31-9AC26	39-2AC26
	 31-1AR26	31-3AR26	31-6AR26	31-6AR26	31-6AR26	31-6AR26	31-9AR26	31-9AR26	39-2AR26
	 31-1AN26	31-3AN26	31-6AN26	31-6AN26	31-6AN26	31-6AN26	31-9AN26	31-9AN26	39-2AN26
	 31-1AC26	31-3AC26	31-6AC26	31-6AC26	31-6AC26	31-6AC26	31-9AC26	31-9AC26	39-2AC26
7 = Plug Polyester Casing	31-1A014**	31-3A014**	31-6A014**	-	31-6A014**	-	61-9A014**	-	-
7 = Plug Metal Casing	-	-	-	39-6A014**	-	39-6A014**	-	39-9A014**	39-2A014**

\* Voltage and phasing positions must be specified (5th, 6th & 7th digit of Part #) to duplicate your shutter and alignment notches.

\*\* For appropriate labeling on a device, please specify voltage, phasing, and product type.

\*\*\* For interiors with pilot contacts, contact Customer Service for part numbers.

<sup>+</sup> For interiors with more than 2 pilot contacts, contact Customer Service for part numbers.

# Spare Parts Female Configuration

DS

DS

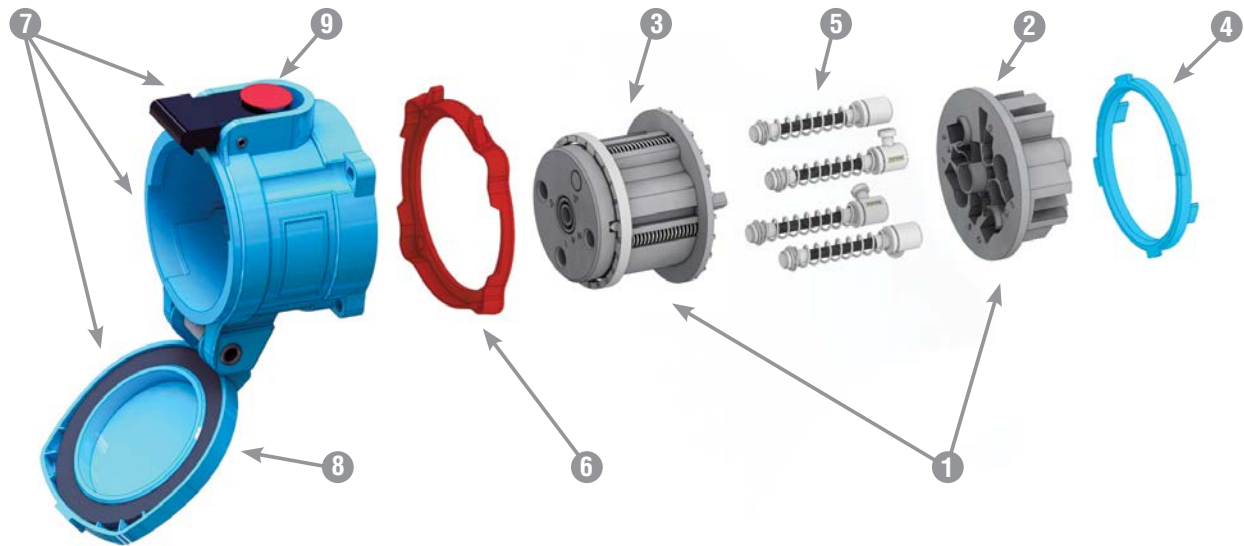

	DS20 POLY	DS30 POLY	DS60 POLY	DS60 METAL	DS100C POLY	DS100C METAL	DS100 POLY	DS100 METAL	DS200 METAL	
① = Receptacle Interior***	31-1A020*	31-3A020*	31-6A020*	31-6A020*	31-6A020-C*	31-6A020-C*	61-9A020*	69-9A020*	39-2A020*	
① = Recept Interior w/Ground Contacts***	-	-	-	39-6A220*	-	39-6A220-C*	-	69-9A220*	39-2A220*	
① = Receptacle Interior with 2 Pilots <sup>†</sup>	31-1A320-972*	31-3A320-972*	31-6A320-972*	31-6A320-972*	31-6A320-C-972*	31-1A320-C-972*	61-9A320-262*	61-9A320-262*	39-2A320-172*	
② = Interior Bottom***	31-1A020-B	31-3A020-B	31-6A020-B	31-6A020-B	31-6A020-C-B	31-6A020-C-B	61-9A552	69-9A552	39-2A020-B	
③ = Interior Top***	31-1A020-T*	31-3A020-T*	31-6A020-T*	31-6A020-T*	31-6A020-C-T*	31-6A020-C-T*	61-9A020-T*	69-9A020-T*	39-2A020-T*	
④ = Polyester Locking Ring	31-1A583	31-3A583	31-6A583	-	31-6A583	-	31-9A583	-	-	
④ = Metal Locking Ring	-	-	-	39-6A583	-	39-6A583	-	39-9A583	39-2A583	
⑤ = Recept Phase Contact (If no aux. contacts)	31-1A021-380	31-3A021-380	31-6A021	31-6A021	31-6A021-C	31-6A021-C	61-9A021	61-9A021	39-2A021	
⑤ = Recept Phase Contact (If plug has aux. contacts)	31-1A021	31-3A021-380	31-6A021	31-6A021	31-6A021-C	31-6A021-C	61-9A021	61-9A021	39-2A021	
⑤ = Recept Ground Contact	31-1A029	31-3A029	31-6A029	39-6A029	31-6A029-C	39-6A029-C	61-9A029	69-9A029	39-2A029	
⑥ = Color-Coded Voltage Gasket	<div style="display: flex; align-items: center;"> <div style="width: 15px; height: 10px; border-radius: 5px; background-color: #004a7c; margin-right: 5px;"></div> <span>208V</span> </div> <div style="display: flex; align-items: center;"> <div style="width: 15px; height: 10px; border-radius: 5px; background-color: #e69d00; margin-right: 5px;"></div> <span>250V</span> </div> <div style="display: flex; align-items: center;"> <div style="width: 15px; height: 10px; border-radius: 5px; background-color: #c00000; margin-right: 5px;"></div> <span>480V</span> </div> <div style="display: flex; align-items: center;"> <div style="width: 15px; height: 10px; border-radius: 5px; background-color: #000000; margin-right: 5px;"></div> <span>600V</span> </div> <div style="display: flex; align-items: center;"> <div style="width: 15px; height: 10px; border-radius: 5px; background-color: #e69d00; margin-right: 5px;"></div> <span>125V</span> </div>	31-1AB26	31-3AB26	31-6AB26	31-6AB26	31-6AB26	31-6AB26	31-9AB26	31-9AB26	39-2AB26
	31-1AC26	31-3AC26	31-6AC26	31-6AC26	31-6AC26	31-6AC26	31-9AC26	31-9AC26	39-2AC26	
	31-1AR26	31-3AR26	31-6AR26	31-6AR26	31-6AR26	31-6AR26	31-9AR26	31-9AR26	39-2AR26	
	31-1AN26	31-3AN26	31-6AN26	31-6AN26	31-6AN26	31-6AN26	31-9AN26	31-9AN26	39-2AN26	
	31-1AC26	31-3AC26	31-6AC26	31-6AC26	31-6AC26	31-6AC26	31-9AC26	31-9AC26	39-2AC26	
⑦ = Receptacle Polyester Casing with Lid	31-1A024**	31-3A024**	31-6A024**	-	31-6A024**	-	61-9A024**	-	-	
⑦ = Receptacle Metal Casing with Lid	-	-	-	39-6A024**	-	39-6A024**	-	39-9A024**	39-2A024**	
⑧ = Lid Replacement Kit Polyester	31-1A125	31-3A125	31-6A125	-	31-6A125	-	61-9A125	-	-	
⑧ = Lid Replacement Kit Metal	-	-	-	39-6A925	-	39-6A925	-	39-9A925	39-2A925	
⑨ = Pawl Replacement Kit Polyester	31-1A824	31-3A824	31-6A824	-	31-6A824	-	61-9A824	-	-	
⑨ = Pawl Replacement Kit Metal	39-1A824	39-3A824	39-6A824	39-6A824	39-6A824	39-6A824	69-9A924	39-9A824	39-2A824	

\* Voltage and phasing positions must be specified (5th, 6th & 7th digit of Part #) to duplicate your shutter and alignment notches.

\*\* For appropriate labeling on a device, please specify voltage, phasing, and product type.

\*\*\* For interiors with more than 2 pilot contacts, contact Customer Service for part numbers.

<sup>†</sup> For interiors with more than 2 pilot contacts, contact Customer Service for part numbers.

For replacement parts contact customer service at 800.433.7642

DS



# Dimensions

## Inlet – Provided in inches

Dimensions are for reference only and may change depending on accessories used. For precise dimensions contact Meltric Engineering.

### plug

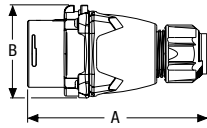

PRODUCT	A	B
DS20/DS24	5.72	2.79
DS30/DS37	6.15	3.23
DS60/DS100C/DS7	6.70	3.77
DS100	8.09	4.79
DS200	10.30	5.67

### Inlet with connector

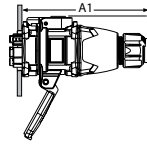

PRODUCT	A1
DS20/DS24	6.67
DS30/DS37	7.05
DS60/DS100C/DS7	8.05
DS100	10.29
DS200	12.44

### Inlet

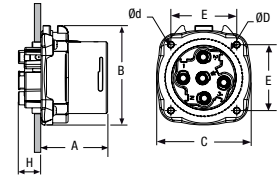

PRODUCT	A	B	C	E	H	Ød	ØD
DS20/DS24	1.86	2.76	2.57	1.89	0.72	0.20	2.07
DS30/DS37	2.07	3.23	3.07	2.17	0.86	0.20	2.48
DS60/DS100C/DS7	2.38	3.77	3.60	2.60	1.04	0.24	3.15
DS100	2.96	4.79	4.50	3.19	1.09	0.24	3.81
DS200	3.20	5.67	5.79	3.86	1.46	0.26	4.57

### 30° inclined inlet/angle with connector

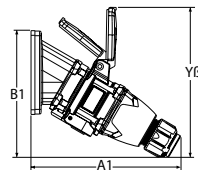

PRODUCT	A1	B1	YB
DS20/DS24	7.50	6.59	7.60
DS30/DS37	8.05	6.89	8.44
DS60/DS100C/DS7	7.90	5.35	9.09
DS100	12.34	10.00	11.34
DS200 60°	11.08	16.81	

### 30° inlet/angle

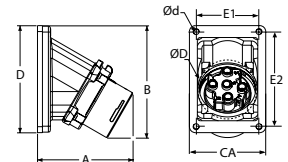

PRODUCT	A	B	CA	D	E1	E2	Ød	ØD
DS20/DS24	3.54	4.56	3.00	4.21	2.48	3.74	0.22	2.25
DS30/DS37	3.93	4.80	3.00	4.21	2.48	3.74	0.22	2.36
DS60/DS100C/DS7	4.42	5.84	4.02	5.35	3.43	4.80	0.26	2.76
DS100	6.11	6.50	5.57	5.57	4.83	4.83	0.28	4.72
DS200 60°	6.90	9.10	7.20	7.20	6.50	6.50	0.25	4.80

### 30° inclined inlet/angle/ junction box with connector

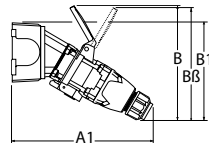

PRODUCT	A1	B	B1	Bβ
DS20/DS24	9.23	7.56	6.74	6.85
DS30/DS37	10.30	7.51	7.02	8.46
DS60/DS100C/DS7	11.87	9.09	8.19	10.00
DS100	16.06	12.24	10.00	
DS200 60°	15.76	16.81	13.66	

### inlet/angle/ metal junction box

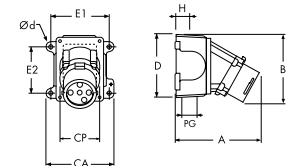

PRODUCT	A	B	CA	CP	D	E1	E2	H	PG	Ød
DS20/DS24	5.89	4.69	4.40	2.48	4.50	4.19	2.75	1.10	1.00	0.27
DS30/DS37	6.26	4.91	4.40	2.48	4.50	4.19	2.75	1.10	1.00	0.27
DS60/DS100C/DS7	7.50	6.00	5.75	3.44	5.84	5.00	3.82	1.50	1.50	0.33
DS100	9.81	6.50	7.50	4.83	5.50	6.75	4.24	1.84	2.00	0.31
DS200 60°	11.60	8.96	9.26	6.50	7.25	8.13	6.38	1.92	2.50	0.31

### 70° inclined inlet/wall box with connector

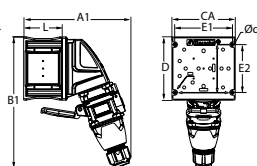

PRODUCT	A1	B1	CA	D	E1	E2	L	Ød
DS20/DS24	8.42	10.50	5.04	5.04	4.57	3.78	3.07	0.26
DS30/DS37	9.53	12.32	6.69	6.69	6.14	5.43	3.07	0.26
DS60/DS100C/DS7	9.84	13.31	6.69	6.69	6.14	5.43	3.07	0.26

### 70° inlet/wall box

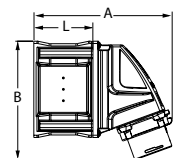

PRODUCT	A	B	L
DS20/DS24	7.17	6.14	3.07
DS30/DS37	8.19	7.70	3.07
DS60/DS100C/DS7	8.31	8.31	3.07



# Dimensions

## Receptacle – Provided in inches

Dimensions are for reference only and may change depending on accessories used. For precise dimensions contact Meltric Engineering.

### connector

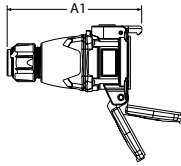

PRODUCT	A1
DS20/DS24	6.38
DS30/DS37	6.93
DS60/DS100C/DS7	7.75
DS100	9.75
DS200	10.87

### receptacle with plug

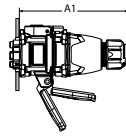

PRODUCT	A1
DS20/DS24	6.67
DS30/DS37	7.05
DS60/DS100C/DS7	8.05
DS100	10.29
DS200	12.06

### receptacle

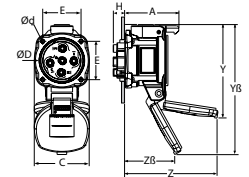

PRODUCT	A	C	E	H	Y	YB	Z	ZB	Ød	ØD
DS20/DS24	2.60	2.61	1.89	0.70	4.14	6.32	4.63	1.93	0.20	2.25
DS30/DS37	2.87	3.04	2.17	0.86	4.48	7.16	4.84	2.33	0.20	2.68
DS60/DS100C/DS7	3.37	3.59	2.60	1.16	6.57	8.46	5.91	2.76	0.22	3.21
DS100	4.60	4.46	3.19	1.09	8.03	10.94	8.70	3.46	0.24	3.81
DS200	4.75	5.16	3.86	1.46	7.99	11.54	8.62	2.48	0.26	4.57

### 30° inclined receptacle/angle with plug

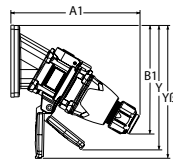

PRODUCT	A1	B1	Y	YB
DS20/DS24	7.50	6.59	6.86	7.87
DS30/DS37	8.05	6.89	8.87	8.44
DS60/DS100C/DS7	7.90	8.07	10.00	10.16
DS100	12.34	10.00	12.05	12.05
DS200 60°	11.08	16.67	15.03	

### 30° receptacle/angle

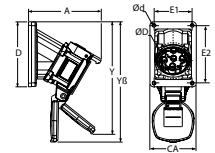

PRODUCT	A	D	E1	E2	Y	YB	Ød	ØD
DS20/DS24	4.51	4.25	2.48	3.74	6.84	7.87	0.22	2.25
DS30/DS37	4.91	4.25	2.48	3.74	8.79	8.43	0.22	2.25
DS60/DS100C/DS7	5.62	5.35	3.43	4.80	9.11	10.32	0.26	2.76
DS100	7.89	5.57	4.83	4.83	12.05	12.05	0.28	4.72
DS200 60°	8.43	7.20	6.50	6.50	15.08		0.25	4.80

### 30° inclined receptacle/angle/ junction box with plug

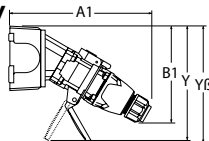

PRODUCT	A1	B1	Y	YB
DS20/DS24	9.84	6.73	7.29	7.94
DS30/DS37	10.30	7.02	8.39	8.39
DS60/DS100C/DS7	11.87	8.19	10.45	9.24
DS100	16.06	9.53	11.77	
DS200 60°	15.76	13.66	11.54	

### receptacle/angle/ metal junction box

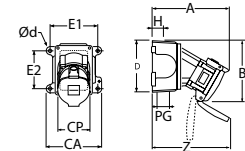

PRODUCT	A	B	CA	CP	D	E1	E2	H	PG	Z	Ød
DS20/DS24	6.86	5.37	4.40	2.61	4.50	4.19	2.75	1.10	1.00	6.77	0.27
DS30/DS37	7.25	5.62	4.40	2.70	4.50	4.19	2.75	1.10	1.00	6.77	0.27
DS60/DS100C/DS7	8.75	7.00	5.75	3.44	5.84	5.00	3.82	1.50	1.50	7.56	0.33
DS100	11.50	7.80	7.50	4.83	5.50	6.75	4.24	1.84	2.00	10.28	0.33
DS200 60°	13.11	9.77	9.25	6.50	7.25	8.13	6.38	1.92	2.50	11.89	0.33

### 70° receptacle/wall box

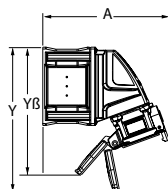

PRODUCT	A	Y	YB
DS20/DS24	8.03	9.25	9.24
DS30/DS37	9.06	9.57	11.30
DS60/DS100C/DS7	9.33	12.56	10.59

### 70° inclined receptacle/wall box with plug

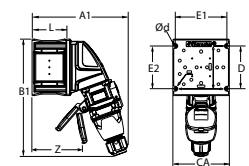

PRODUCT	A1	B1	CA	D	E1	E2	L	Z	Ød
DS20/DS24	8.41	10.50	5.00	5.00	4.57	3.78	3.07	4.91	0.26
DS30/DS37	9.53	12.32	6.69	6.69	6.14	5.43	3.07	4.91	0.26
DS60/DS100C/DS7	9.76	13.03	6.69	6.69	6.22	5.47	3.07	4.09	0.26