

Product data sheet

Specifications

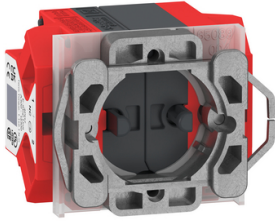

E-Stop Non-illuminated Body, Harmony 9001K/Harmony 9001SK, KR/SKR18, Metal/Plastic, 2NC, pre- assembled and non-disassembly

9001KES18RES2

Product availability: Stock - Normally stocked in distribution facility

Main

Range of Product	Harmony 9001K Harmony 9001SK
Product or Component Type	Contact block
Device short name	9001K
Fixing collar material	Metal
Contacts type and composition	2 NC

Complementary

Net Weight	0.185 lb(US) (0.084 kg)
Contact operation	Positive opening
Positive opening	With NC contact IEC 60947-5-5
Connections - terminals	Screw clamp terminals, 1 x 0.34...1 x 1.5 mm ² IEC 60947-1
Tightening torque	9.7 lbf.in (1.1 N.m) IEC 60947-1
Shape of screw head	Cross slotted
Contacts material	Silver alloy contacts
Short-circuit protection	10 A cartridge fuse gG IEC 60947-5-1
[Ith] conventional free air thermal current	10 A
[Ui] rated insulation voltage	250 V 3)IEC 60947-1
[Uimp] rated impulse withstand voltage	2.5 kV IEC 60947-1
[Ie] rated operational current	3 A 240 V, AC-15, A300-Q300 UL 60947-5-1
[Icm] rated short-circuit making capacity	1 kA 300 V AC-15, 7200 VA
Rated breaking capacity	3 A 240 V AC-15, 720 VA
Device presentation	Emergency stop body
CAD overall height	1.6 in (40.8 mm)
CAD overall width	2.1 in (53.5 mm)
CAD overall depth	1.6 in (40.4 mm)

Environment

Ambient Air Temperature for Storage	-40...158 °F (-40...70 °C)
Ambient Air Temperature for Operation	-13...158 °F (-25...70 °C)

Price is "List Price" and may be subject to a trade discount – check with your local distributor or retailer for actual price.

Standards	IEC 60947-5-1 IEC 60947-5-5 UL 60947-5-1 UL 60947-5-5
Product Certifications	UL CSA CE ABS (Marine)
Vibration resistance	7 gn (f= 2...500 Hz) conforming to IEC 60068-2-6
Shock resistance	50 gn 11 ms) IEC 60068-2-27

Ordering and shipping details

Category	US10CS121426
Discount Schedule	0CS1
GTIN	3606487209126
Returnability	Yes
Country of origin	MX

Packing Units

Unit Type of Package 1	PCE
Nbr. of units in pkg.	1
Package 1 Height	2.100 in (5.334 cm)
Package 1 Width	2.300 in (5.842 cm)
Package 1 Length	3.000 in (7.620 cm)
Package weight(Lbs)	3.840 oz (108.862 g)

Contractual warranty

Warranty (in months)	18
-----------------------------	----



Environmental Data

Schneider Electric aims to achieve Net Zero status by 2050 through supply chain partnerships, lower impact materials, and circularity via our ongoing “Use Better, Use Longer, Use Again” campaign to extend product lifetimes and recyclability.

[Environmental Data explained >](#)

[How we assess product sustainability >](#)



Environmental footprint

Total lifecycle Carbon footprint	1 kg CO2 eq.
Environmental Disclosure	Product Environmental Profile
Carbon footprint of the manufacturing phase [A1 to A3]	0.6 kg CO2 eq.
Carbon footprint of the distribution phase [A4]	0.1 kg CO2 eq.
Carbon footprint of the installation phase [A5]	0 kg CO2 eq.
Carbon footprint of the use phase [B2, B3, B4, B6]	0.1 kg CO2 eq.
Carbon footprint of the end-of-life phase [C1 to C4]	0.3 kg CO2 eq.

Use Better



Materials and Substances

EU RoHS Directive	Compliant
REACH Regulation	REACH Declaration
California proposition 65	WARNING: This product can expose you to chemicals including: Lead and lead compounds, which is known to the State of California to cause cancer and birth defects or other reproductive harm. For more information go to www.P65Warnings.ca.gov

Use Longer



Lifetime extension

Repair	No
--------	----

Use Again



Repack and remanufacture

Recyclability potential, in %	60
Circularity Profile	End of Life Information
Take-back	No
WEEE Label	 The product must be disposed on European Union markets following specific waste collection and never end up in rubbish bins.

Dimensions Drawings

Dimensions

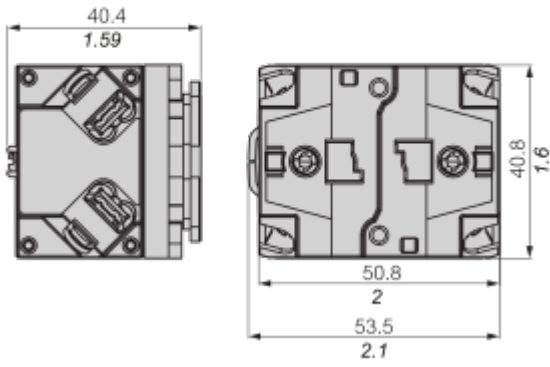

$\frac{\text{mm}}{\text{in.}}$

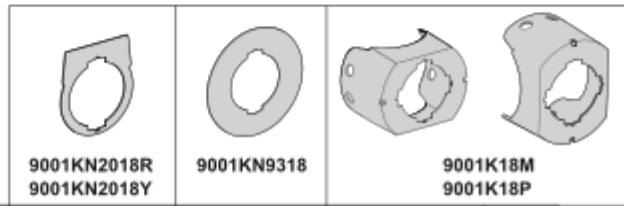
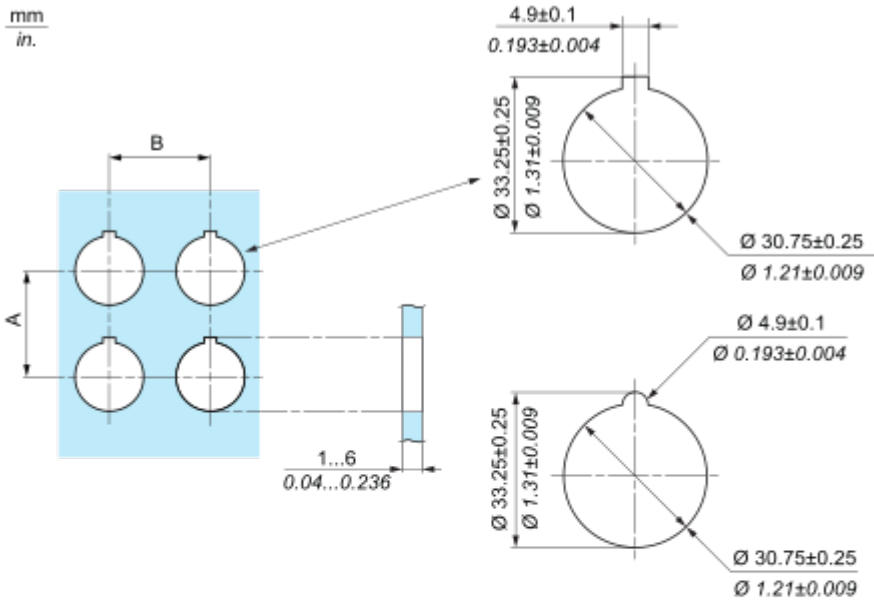

Mounting and Clearance

Panel cut-out



			 9001KN2018R 9001KN2018Y	 9001KN9318	 9001K18M 9001K18P		
A	mm	44.5	52.5	76	54	71	
	in.	1.75	2.07	3.0	2.13	2.80	
B	mm	57.2	57.2	76	71	57.2	
	in.	2.25	2.25	3.0	2.80	2.25	

Technical Illustration

Dimensions

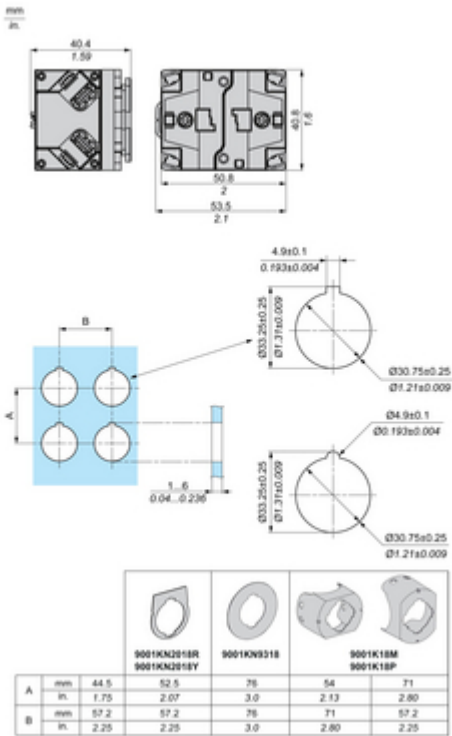

Offer Marketing Illustration

Product benefits / Features

Features
Harmony 9001K



- 

Improved security thanks to finger-safe contact blocks and light modules
- 

Single screw Contact Block Fastening
- 

Robustness to withstand the harshest environments
- 

Automatic self-grounding operators without additional wiring
- 

Large metal set of accessories to customize your product

Offer Marketing Illustration

Product benefits / Features

Technical Benefits

Harmony 9001K



Image of product / Alternate images

Alternative

