











Siemens
EcoTech



Selector switch, illuminable, 22 mm, round, plastic, yellow, selector switch, short, 3 switch positions I-O-II, latching, actuating angle 2x45°, 10:30h/12h/13:30h



product brand name	SIRIUS ACT
product designation	Selector switches
design of the product	Actuating/signaling element
product type designation	3SU1
product line	Plastic, black, 22 mm
Enclosure	
number of command points	1
Actuator	
design of the actuating element	Selector, short
principle of operation of the actuating element	latching, 2x45° (10:30 h/12 h/13:30 h)
product extension optional	
• light source	Yes
• contact module	Yes
color of the actuating element	yellow
material of the actuating element	plastic
shape of the actuating element	Handle
outer diameter of the actuating element	32.3 mm
number of switching positions	3
actuating angle	
• clockwise	45°
• anticlockwise	45°
Front ring	
product component front ring	Yes
design of the front ring	standard
material of the front ring	plastic
color of the front ring	black
General technical data	
protection class IP	IP66, IP67, IP69(IP69K)
degree of protection NEMA rating	1, 2, 3, 3R, 4, 4X, 12, 13
shock resistance	
• according to IEC 60068-2-27	sinusoidal half-wave 15g / 11 ms
• for railway applications according to EN 61373	Category 1, Class B
vibration resistance	
• according to IEC 60068-2-6	10 ... 500 Hz: 5g
• for railway applications according to EN 61373	Category 1, Class B
operating frequency maximum	1 800 1/h
mechanical service life (operating cycles) typical	1 000 000

reference code according to IEC 81346-2	S	
Substance Prohibittance (Date)	10/01/2014	
Weight	22 g	
Safety related data		
proportion of dangerous failures		
<ul style="list-style-type: none"> with low demand rate according to SN 31920 	20 %	
<ul style="list-style-type: none"> with high demand rate per NC contact according to SN 31920 	20 %	
<ul style="list-style-type: none"> with high demand rate per NO contact according to SN 31920 	50 %	
B10 value with high demand rate according to SN 31920	300 000	
failure rate [FIT] with low demand rate per NC contact according to SN 31920	100 FIT	
IEC 61508		
T1 value for proof test interval or service life according to IEC 61508	20 a	
Ambient conditions		
ambient temperature		
<ul style="list-style-type: none"> during operation 	-25 ... +70 °C	
<ul style="list-style-type: none"> during storage 	-40 ... +80 °C	
environmental category during operation according to IEC 60721	3M6, 3S2, 3B2, 3C3, 3K6 (with relative air humidity of 10 ... 95%)	
Environmental footprint		
Environmental Product Declaration (EPD)	Yes	
global warming potential [CO2 eq] total	0.787 kg	
global warming potential [CO2 eq] during manufacturing	0.566 kg	
global warming potential [CO2 eq] during operation	0.235 kg	
global warming potential [CO2 eq] after end of life	-0.015 kg	
Siemens Eco Profile (SEP)	Siemens EcoTech	
Installation/ mounting/ dimensions		
height	32.3 mm	
width	32.3 mm	
shape of the installation opening	round	
mounting diameter	22.3 mm	
positive tolerance of installation diameter	0.4 mm	
mounting height	28.8 mm	
installation width	32.3 mm	
installation depth	25.4 mm	
Approvals Certificates		
General Product Approval	Test Certificates	
   	Special Test Certificate Type Test Certificates/Test Report	
Maritime application	other	Environment
  		Confirmation 
Environment		
	Environmental Confirmations	
Further information		

Information on the packaging

<https://support.industry.siemens.com/cs/ww/en/view/109813875>

Information for data generation and storage

<https://support.industry.siemens.com/cs/ww/en/view/109995012>

Information- and Downloadcenter (Catalogs, Brochures,...)

<https://www.siemens.com/ic10>

Industry Mall (Online ordering system)

<https://mall.industry.siemens.com/mall/en/en/Catalog/product?mlfb=3SU1002-2BL30-0AA0>

Cax online generator

<http://support.automation.siemens.com/WW/CAXorder/default.aspx?lang=en&mlfb=3SU1002-2BL30-0AA0>

Service&Support (Manuals, Certificates, Characteristics, FAQs,...)

<https://support.industry.siemens.com/cs/ww/en/ps/3SU1002-2BL30-0AA0>

Image database (product images, 2D dimension drawings, 3D models, device circuit diagrams, EPLAN macros, ...)

http://www.automation.siemens.com/bilddb/cax_de.aspx?mlfb=3SU1002-2BL30-0AA0&lang=en

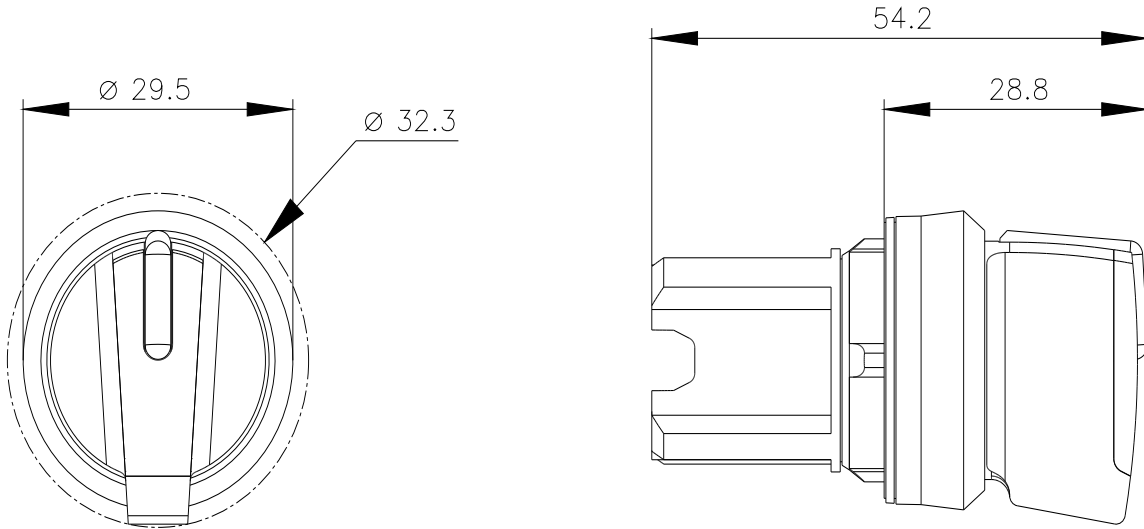

last modified:

5/21/2025 