

Siemens
EcoTech



mushroom pushbutton, 22 mm, round, metal, shiny, black, 40 mm, positive latching, rotate to unlatch





product brand name	SIRIUS ACT
product designation	Mushroom pushbuttons
design of the product	Actuating/signaling element
product type designation	3SU1
product line	Metal, shiny, 22 mm
Enclosure	
number of command points	1
Actuator	
design of the actuating element	positive latching
principle of operation of the actuating element	latching
product extension optional light source	No
color of the actuating element	black
material of the actuating element	plastic
shape of the actuating element	round
outer diameter of the actuating element	40 mm
type of unlocking device	rotate-to-unlatch mechanism
number of switching positions	2
Front ring	
product component front ring	No
design of the front ring	without
General technical data	
product function	
• EMERGENCY OFF function	No
• EMERGENCY STOP function	No
protection class IP	IP66, IP67, IP69(IP69K)
degree of protection NEMA rating	1, 2, 3, 3R, 4, 4X, 12, 13
shock resistance	
• according to IEC 60068-2-27	sinusoidal half-wave 15g / 11 ms
vibration resistance	
• according to IEC 60068-2-6	10 ... 500 Hz: 5g
operating frequency maximum	600 1/h
mechanical service life (operating cycles) typical	300 000
reference code according to IEC 81346-2	S
Substance Prohibitance (Date)	10/01/2014
Weight	95 g
Ambient conditions	
ambient temperature	



<ul style="list-style-type: none"> during operation during storage 	-25 ... +70 °C -40 ... +80 °C
environmental category during operation according to IEC 60721	3M6, 3S2, 3B2, 3C3, 3K6 (with relative air humidity of 10 ... 95%)

Environmental footprint	
Environmental Product Declaration (EPD)	Yes
global warming potential [CO2 eq] total	0.593 kg
global warming potential [CO2 eq] during manufacturing	0.625 kg
global warming potential [CO2 eq] during operation	0.235 kg
global warming potential [CO2 eq] after end of life	-0.267 kg
Siemens Eco Profile (SEP)	Siemens EcoTech

Installation/ mounting/ dimensions	
height	40 mm
width	40 mm
shape of the installation opening	round
mounting diameter	22.3 mm
positive tolerance of installation diameter	0.4 mm
mounting height	45.3 mm
installation width	40 mm
installation depth	26.3 mm

Approvals Certificates

General Product Approval	Test Certificates
   	Type Test Certificates/Test Report Special Test Certificate

Maritime application	other	Environment
  		Confirmation 

Environment
 Environmental Confirmations

Further information

Information on the packaging
<https://support.industry.siemens.com/cs/ww/en/view/109813875>
Information for data generation and storage
<https://support.industry.siemens.com/cs/ww/en/view/109995012>
Information- and Downloadcenter (Catalogs, Brochures,...)
<https://www.siemens.com/ic10>
Industry Mall (Online ordering system)
<https://mall.industry.siemens.com/mall/en/en/Catalog/product?mlfb=3SU1050-1HB10-0AA0>
Cax online generator
<http://support.automation.siemens.com/WWW/CAXorder/default.aspx?lang=en&mlfb=3SU1050-1HB10-0AA0>
Service&Support (Manuals, Certificates, Characteristics, FAQs,...)
<https://support.industry.siemens.com/cs/ww/en/ps/3SU1050-1HB10-0AA0>
Image database (product images, 2D dimension drawings, 3D models, device circuit diagrams, EPLAN macros, ...)
http://www.automation.siemens.com/bilddb/cax_de.aspx?mlfb=3SU1050-1HB10-0AA0&lang=en

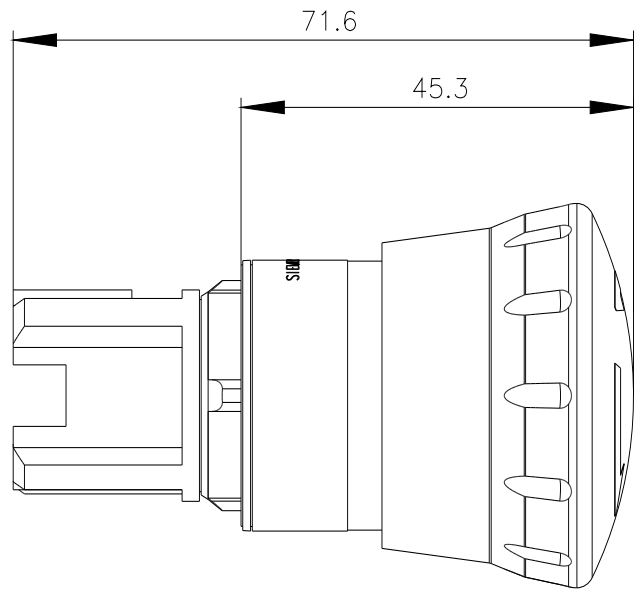
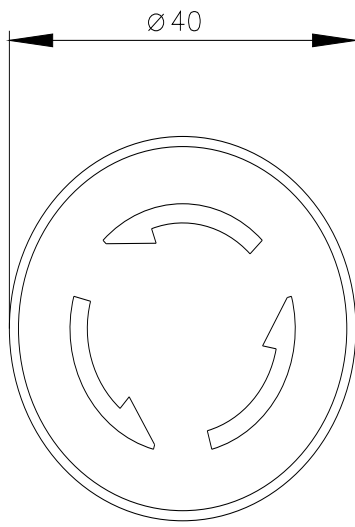

last modified:

4/2/2025 