

Operator panel titanium gray, installation in control cabinet door or front plate, can be plugged onto basic unit or extension modules, 10 LEDs for status display and 5 freely assignable keys for manual control



Product brand name	SIRIUS
Product designation	operator panels

General technical data

Insulation voltage	
• rated value	300 V
Surge voltage resistance rated value	4 000 V
Protection class IP	
• on the front	IP54
Vibration resistance	1-6 Hz / 15 mm; 6-500 Hz / 2 g
Reference code acc. to DIN EN 81346-2	A
Reference code acc. to DIN EN 61346-2	A

Electromagnetic compatibility

EMC emitted interference	
• acc. to IEC 60947-1	class A
EMI immunity acc. to IEC 60947-1	corresponds to degree of severity 3
Conducted interference	
• due to burst acc. to IEC 61000-4-4	1 kV
• due to conductor-earth surge acc. to IEC 61000-4-5	2 kV

<ul style="list-style-type: none"> • due to conductor-conductor surge acc. to IEC 61000-4-5 	1 kV
Field-bound parasitic coupling acc. to IEC 61000-4-3	10 V/m





Installation/ mounting/ dimensions





Mounting position	any
Mounting type	front mounting
Height	36 mm
Width	96 mm
Depth	44 mm

Ambient conditions

Installation altitude at height above sea level	
<ul style="list-style-type: none"> • maximum 	4 000 m
<ul style="list-style-type: none"> • 1 maximum 	2 000 m
<ul style="list-style-type: none"> • 2 maximum 	3 000 m; No protective separation at 50 °C
<ul style="list-style-type: none"> • 3 maximum 	4 000 m; No protective separation at 40 °C
Ambient temperature	
<ul style="list-style-type: none"> • during operation 	-25 ... +60 °C
Environmental category	
<ul style="list-style-type: none"> • during operation acc. to IEC 60721 	3K6 (no formation of ice, no condensation, relative humidity 10 ... 95%), 3C3 (no salt mist), 3S2 (sand must not get into the devices), 3M6
<ul style="list-style-type: none"> • during storage acc. to IEC 60721 	1K6 (no condensation, relative humidity 10 ... 95%), 1C2 (no salt mist), 1S2 (sand must not get into the devices), 1M4
<ul style="list-style-type: none"> • during transport acc. to IEC 60721 	2K2, 2C1, 2S1, 2M2

Certificates/ approvals

General Product Approval			EMC	Declaration of Conformity	Test Certificates
 CSA	 UL		 RCM	 EG-Konf.	Type Test Certificates/Test Report

Marine / Shipping			other		
 ABS	 RMRS	 DNVGL.COM/AF	Confirmation	PROFIsafe-Certification	 Profibus

other
PROFINET-Certification

Further information

Information- and Downloadcenter (Catalogs, Brochures,...)

www.siemens.com/sirius/catalogs

Industry Mall (Online ordering system)

<https://mall.industry.siemens.com/mall/en/en/Catalog/product?mlfb=3UF7200-1AA01-0>

Cax online generator

<http://support.automation.siemens.com/WW/CAXorder/default.aspx?lang=en&mlfb=3UF7200-1AA01-0>

Service&Support (Manuals, Certificates, Characteristics, FAQs,...)

<https://support.industry.siemens.com/cs/ww/en/ps/3UF7200-1AA01-0>

Image database (product images, 2D dimension drawings, 3D models, device circuit diagrams, EPLAN macros, ...)

http://www.automation.siemens.com/bilddb/cax_de.aspx?mlfb=3UF7200-1AA01-0&lang=en

Test report No. A0258, protective separation

<https://support.industry.siemens.com/cs/ww/en/view/109748152>

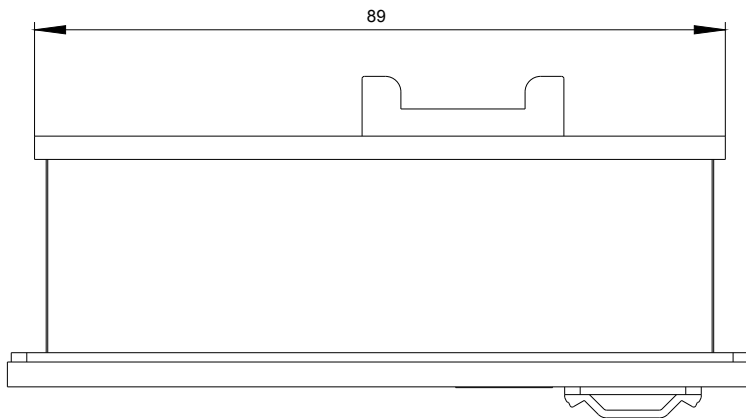
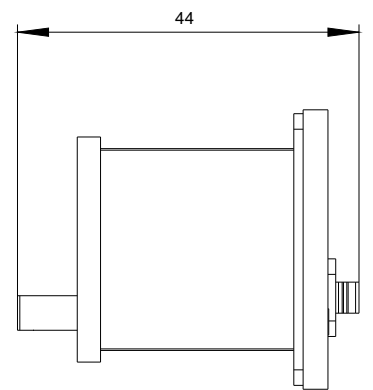
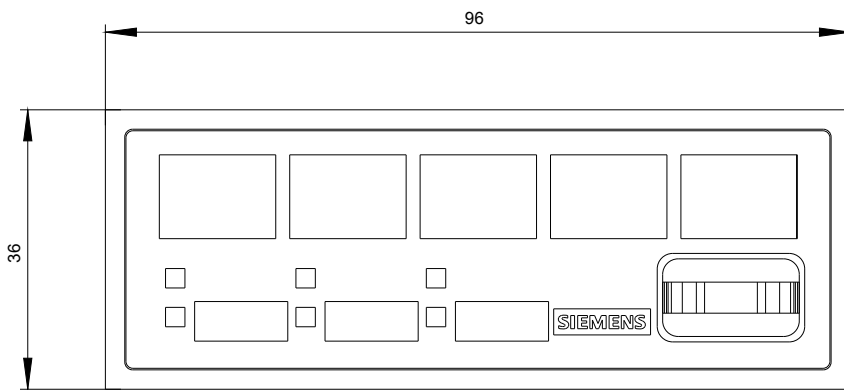

-K

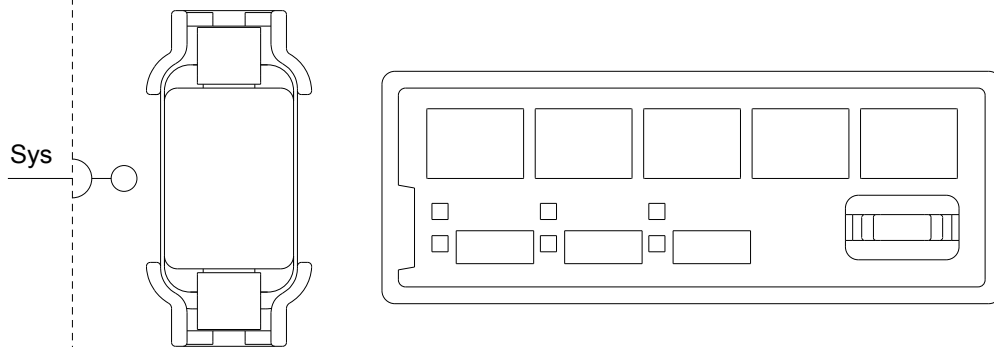

SIMOCODE PRO

last modified:

07/26/2019