

# Data Sheet | Item Number: 750-626

Supply Filter; 24 VDC

<https://www.wago.com/750-626>

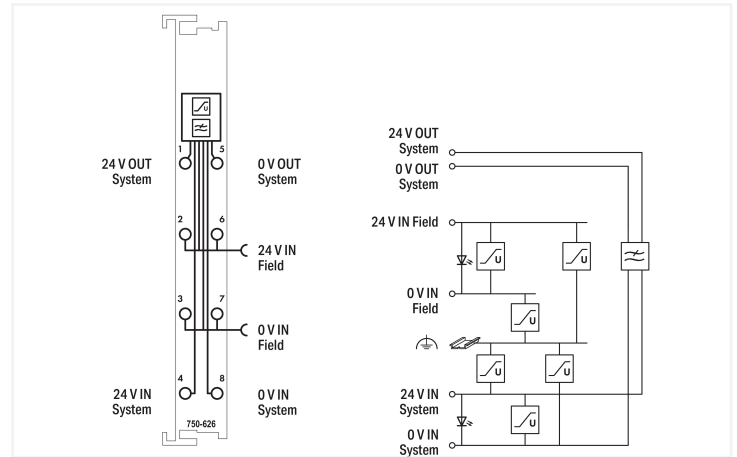
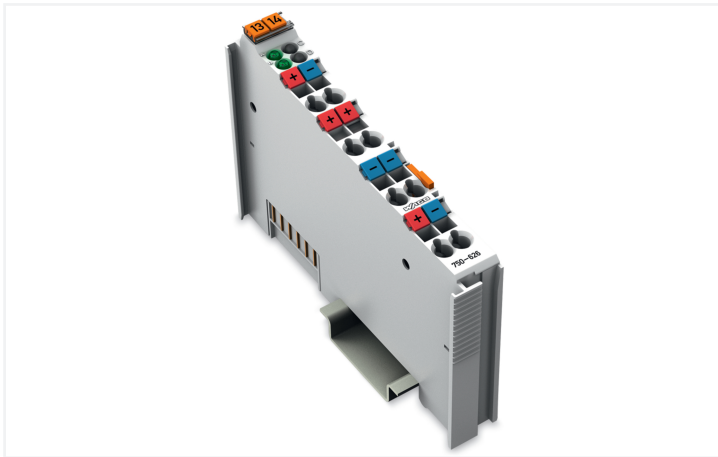

Color: ■ light gray

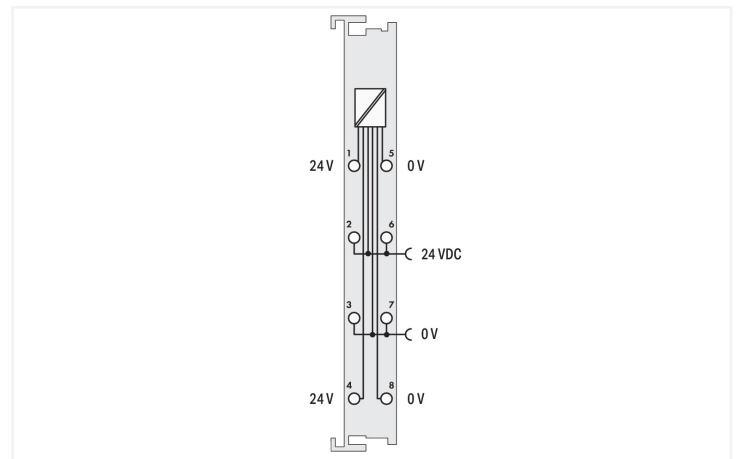
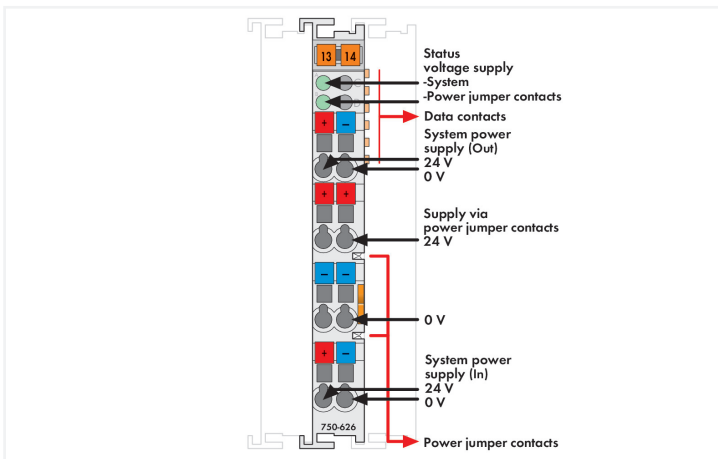

The WAGO I/O System 750 can also be used in marine applications and onshore/offshore installations (e.g., platforms, loading facilities). This is possible via certification under the standards of leading agencies such as Germanischer Lloyd and Lloyd's Register. This filter module ensures proper (certified) system operation. The module filters the 24 V system power supply and is equipped with surge suppression. High-insulation versions are streamlined for use in systems with insulation monitoring.

Technical data	
Signal type	Voltage
Signal type (voltage)	24 VDC
Supply voltage (system)	24 VDC (-25 ... +30 %); Via wiring interface (CAGE CLAMP® connection); External fuse required: 2 A slow-blow
Supply voltage (field)	24 VDC (-25 ... +30 %); Via power jumper contacts (supply via CAGE CLAMP® connection; distribution via spring contact); External fuse required: 10 A slow-blow
Current via system voltage (max.)	1.5 A (1 A up to hardware version 03)
Current carrying capacity (power jumper contacts)	10 A
Number of outgoing power jumper contacts	2
Use	Marine-certified operation in conjunction with the Ex i supply module and the use of 750 Series PROFIsafe Modules
Indicators	LED (A, B) green: operating voltage status: system, power jumper contacts

### Connection Data

Connectable conductor materials	Copper
Connection type	System/field supply
Solid conductor	0.08 ... 2.5 mm <sup>2</sup> / 28 ... 14 AWG
Fine-stranded conductor	0.08 ... 2.5 mm <sup>2</sup> / 28 ... 14 AWG
Strip length	8 ... 9 mm / 0.31 ... 0.35 inches
Connection technology: field supply	4 x CAGE CLAMP®
Connection technology: system supply	4 x CAGE CLAMP®

### Physical data

Width	12 mm / 0.472 inches
Height	100 mm / 3.937 inches
Depth	69.8 mm / 2.748 inches
Depth from upper-edge of DIN-rail	62.6 mm / 2.465 inches

### Mechanical data

Mounting type	DIN-35 rail
Pluggable connector	fixed

### Material data

Color	light gray
Housing material	Polycarbonate; polyamide 6.6
Fire load	1.26 MJ
Weight	49.6 g
Conformity marking	CE

### Environmental requirements

Ambient temperature (operation)	0 ... +55 °C
Ambient temperature (storage)	-40 ... +85 °C
Protection type	IP20
Pollution degree	2 per IEC 61131-2
Operating altitude	0 ... 2000 m / 0 ... 6562 ft
Mounting position	Horizontal left, horizontal right, horizontal top, horizontal bottom, vertical top and vertical bottom
Relative humidity (without condensation)	95 %
Vibration resistance	4g per IEC 60068-2-6
Shock resistance	15g per IEC 60068-2-27
EMC immunity to interference	per EN 61000-6-2, marine applications
EMC emission of interference	per EN 61000-6-4, marine applications
Exposure to pollutants	per IEC 60068-2-42 and IEC 60068-2-43
Permissible H <sub>2</sub> S contaminant concentration at a relative humidity 75 %	10 ppm
Permissible SO <sub>2</sub> contaminant concentration at a relative humidity 75 %	25 ppm

### Commercial data

Product Group	15 (I/O System)
PU (SPU)	1 pcs
Packaging type	Box
Country of origin	DE
GTIN	4045454393977
Customs tariff number	85389091890

### Product Classification

UNSPSC	39121610
eCl@ss 10.0	27-24-26-10
eCl@ss 9.0	27-24-26-10
ETIM 9.0	EC001600
ETIM 10.0	EC001600
ECCN	NO US CLASSIFICATION

### Environmental Product Compliance

CAS-No.	1303-86-2 1317-36-8 7439-92-1
REACH Candidate List Substance	Diboron trioxide Lead Lead monoxide
RoHS Compliance Status	Compliant,With Exemption
RoHS Exemption	7(a) 7(c)-I
SCIP notification number (Austria)	67c0c0b1-7384-4b47-a2e5-4c27138899d5
SCIP notification number (Belgium)	df0f77b2-d61d-4ad6-a3b3-f7711ef98d42
SCIP notification number (Bulgaria)	2d06e6ca-d722-4510-b42c-65e6403fa9d5
SCIP notification number (Czech Republic)	a68e4cdd-5f5a-418b-8e5e-e803e77fca65
SCIP notification number (Denmark)	64efa0c4-e047-4e42-be2c-7ac2c5682a5f
SCIP notification number (Finland)	1d58eed1-1e70-4a5c-b275-94ef51c4b0e6
SCIP notification number (France)	4e0a8b03-54ed-4246-ae5c-7b0f6059a324
SCIP notification number (Germany)	44af5fb9-ca85-4975-b391-63f66ebec7da
SCIP notification number (Hungary)	96033c53-5b69-4a96-822d-d0cd90af0ac2
SCIP notification number (Italy)	cf47825e-5dc0-4974-bde0-53ea3b2effe4
SCIP notification number (Netherlands)	aae1ec69-6acb-4163-9a02-4744f8d8f656
SCIP notification number (Poland)	2e19eca4-0e0c-4291-a245-0b850a9e3ac2
SCIP notification number (Romania)	4edd15ad-8a94-49aa-bbc0-cf5351cee8b9
SCIP notification number (Sweden)	caf61d73-0270-4183-8472-a7cf01e7c216

### Approvals / Certificates

#### General approvals



Approval	Standard	Certificate Name
EAC GZO Almaty Standart	TP TC 020/2011	EAC CoC 03083
KC National Radio Research Agency	Article 58-2, Clause 3	MSIP-REM-W43-IDE750
UL Underwriters Laboratories Inc. (ORDINARY LOCATIONS)	UL 508	E175199

#### Declarations of conformity and manufacturer's declarations

Approval	Standard	Certificate Name
EU-Declaration of Conformity WAGO GmbH & Co. KG	-	-
UK-Declaration of Conformity WAGO GmbH & Co. KG	-	-

Approvals for marine applications



Approval	Standard	Certificate Name
ABS American Bureau of Shipping	-	25-0415412
BSH Bundesamt fuer Seeschiff-fahrt und Hydrographie	-	1104
BV Bureau Veritas S.A.	-	13453/E0 BV
DNV DNV GL SE	DNV-CG-0339,Aug.2021	TAA0000194
KR Korean Register of Shipping	-	KR HMB05880-AC001
LR Lloyds Register EMEA	-	LR22180952TA
PRS Polski Rejestr Statków	-	TE/1101/880590/23
RINA RINA Germany GmbH	-	ELE343521XG001

Approvals for hazardous areas



Approval	Standard	Certificate Name
ATEX TUEV Nord Cert GmbH	EN 60079-0	TUEV14ATEX148929X (II 3 G Ex ec IIC T4 Gc)
CCCEX CQST/CNEx	CNCA-C23-01	2020312310000213 (Ex ec IIC T4 Gc)
IECEX TUEV Nord Cert GmbH	IEC 60079-0	IECEX TUN 14.0035 X (Ex ec IIC T4 Gc)
INMETRO TÜV Rheinland do Brasil Ltda.	IEC 60079-0	TÜV 12.1297 X
KTL Korea Testing Laboratory	KOSHA Article 34, IEC60079-0	21-KA4BO-0554X
UKEx WAGO GmbH & Co. KG	EN 60079-0	UKCA_WA GO22UKEX003X_ec
UL Underwriters Laboratories Inc. (HAZARDOUS LOCATIONS)	UL 121201	E198726

Downloads

Environmental Product Compliance

Compliance Search

Environmental Product Compliance 750-626	<a href="#">↓</a>
--	-------------------

Documentation

Manual			
Product Manual Filter module	2722023691   1   en-US   2025-12-19 12:35 21.01.2026	pdf 876.49 KB	<a href="#">↓</a>
System Manual Series 750/753			<a href="#">↓</a>

System Description			
750/753 Series I/O-System – General Product Information		pdf 953.35 KB	<a href="#">↓</a>
Overview on WAGO-I/O-SYSTEM 750 approvals		pdf 770.48 KB	<a href="#">↓</a>

Bid Text

750-626	19.02.2019	xml 4.47 KB	<a href="#">↓</a>
750-626	06.10.2017	doc 27.50 KB	<a href="#">↓</a>

Instruction Leaflet

CCC Ex (Additional information)	26.04.2023	pdf 159.76 KB	<a href="#">↓</a>
---------------------------------	------------	------------------	-------------------

## CAD/CAE-Data

**CAD data**  
2D/3D Models 750-626

**CAE data**  
EPLAN Data Portal 750-626

WSCAD Universe 750-626

ZUKEN Portal 750-626

## Device Files

**Device Driver**  
WAGO USB Service Kabel Treiber / Serie 750 und 857 6.5.3.0 10.09.2014 zip 4721.96 KB

## 1 Compatible Products

### 1.1 Optional Accessories

#### 1.1.1 DIN-rail

##### 1.1.1.1 Mounting accessories



**Item No.: 210-196**  
Aluminum carrier rail; 35 x 8.2 mm; 1.6 mm thick; 2 m long; unslotted; similar to EN 60715; silver-colored



**Item No.: 210-198**  
Copper carrier rail; 35 x 15 mm; 2.3 mm thick; 2 m long; unslotted; according to EN 60715; copper-colored



**Item No.: 210-197**  
Steel carrier rail; 35 x 15 mm; 1.5 mm thick; 2 m long; slotted; similar to EN 60715; silver-colored



**Item No.: 210-114**  
Steel carrier rail; 35 x 15 mm; 1.5 mm thick; 2 m long; unslotted; similar to EN 60715; silver-colored



**Item No.: 210-118**  
Steel carrier rail; 35 x 15 mm; 2.3 mm thick; 2 m long; unslotted; according to EN 60715; silver-colored



**Item No.: 210-115**  
Steel carrier rail; 35 x 7.5 mm; 1 mm thick; 2 m long; slotted; according to EN 60715; "Hole width 18 mm; silver-colored



**Item No.: 210-112**  
Steel carrier rail; 35 x 7.5 mm; 1 mm thick; 2 m long; slotted; according to EN 60715; "Hole width 25 mm; silver-colored



**Item No.: 210-113**  
Steel carrier rail; 35 x 7.5 mm; 1 mm thick; 2 m long; unslotted; according to EN 60715; silver-colored

### 1.1.2 Marking

#### 1.1.2.1 Group marker carrier



**Item No.: 750-106**  
Group marker carrier

#### 1.1.2.2 Marker



**Item No.: 750-100**  
Marker card; as a DIN A4 sheet; plain

**Item No.: 2009-145/000-006**  
Mini-WSB Inline; for Smart Printer; 1700 pieces on roll; stretchable 5 - 5.2 mm; plain; snap-on type; blue

**Item No.: 2009-145/000-007**  
Mini-WSB Inline; for Smart Printer; 1700 pieces on roll; stretchable 5 - 5.2 mm; plain; snap-on type; gray

**Item No.: 2009-145/000-023**  
Mini-WSB Inline; for Smart Printer; 1700 pieces on roll; stretchable 5 - 5.2 mm; plain; snap-on type; green











**Item No.: 2009-145/000-012**  
Mini-WSB Inline; for Smart Printer; 1700 pieces on roll; stretchable 5 - 5.2 mm; plain; snap-on type; orange

**Item No.: 2009-145/000-005**  
Mini-WSB Inline; for Smart Printer; 1700 pieces on roll; stretchable 5 - 5.2 mm; plain; snap-on type; red

**Item No.: 2009-145/000-024**  
Mini-WSB Inline; for Smart Printer; 1700 pieces on roll; stretchable 5 - 5.2 mm; plain; snap-on type; violet

**Item No.: 2009-145**  
Mini-WSB Inline; for Smart Printer; 1700 pieces on roll; stretchable 5 - 5.2 mm; plain; snap-on type; white

**1.1.2.2 Marker**



 <p><b>Item No.: 2009-145/000-002</b> Mini-WSB Inline; for Smart Printer; 1700 pieces on roll; stretchable 5 - 5.2 mm; plain; snap-on type; yellow</p>	 <p><b>Item No.: 248-501/000-006</b> Mini-WSB marking card; as card; not stretchable; plain; snap-on type; blue</p>	 <p><b>Item No.: 248-501/000-007</b> Mini-WSB marking card; as card; not stretchable; plain; snap-on type; gray</p>	 <p><b>Item No.: 248-501/000-023</b> Mini-WSB marking card; as card; not stretchable; plain; snap-on type; green</p>
 <p><b>Item No.: 248-501/000-017</b> Mini-WSB marking card; as card; not stretchable; plain; snap-on type; light green</p>	 <p><b>Item No.: 248-501/000-012</b> Mini-WSB marking card; as card; not stretchable; plain; snap-on type; orange</p>	 <p><b>Item No.: 248-501/000-005</b> Mini-WSB marking card; as card; not stretchable; plain; snap-on type; red</p>	 <p><b>Item No.: 248-501/000-024</b> Mini-WSB marking card; as card; not stretchable; plain; snap-on type; violet</p>
 <p><b>Item No.: 248-501</b> Mini-WSB marking card; as card; not stretchable; plain; snap-on type; white</p>	 <p><b>Item No.: 248-501/000-002</b> Mini-WSB marking card; as card; not stretchable; plain; snap-on type; yellow</p>		

**1.1.2.3 Marker carrier**

 <p><b>Item No.: 750-103</b> Group marker carrier</p>
--

**1.1.3 Shield termination**

**1.1.3.1 Shield clamping saddles**

 <p><b>Item No.: 790-108</b> Shield clamping saddle; 11 mm wide; diameter of compatible conductor; 3 ... 8 mm</p>	 <p><b>Item No.: 790-208</b> Shield clamping saddle; 12.4 mm wide; 3 ... 8 mm</p>	 <p><b>Item No.: 790-116</b> Shield clamping saddle; 19 mm wide; diameter of compatible conductor; 7 ... 16 mm</p>	 <p><b>Item No.: 790-216</b> Shield clamping saddle; 21.8 mm wide; 6 ... 16 mm</p>
 <p><b>Item No.: 790-124</b> Shield clamping saddle; 27 mm wide; diameter of compatible conductor; 6 ... 24 mm</p>	 <p><b>Item No.: 790-220</b> Shield clamping saddle; 30 mm wide; 6 ... 20 mm</p>	 <p><b>Item No.: 790-140</b> Shield clamping saddle; diameter of compatible conductor</p>	

**1.1.4 System enclosure**

**1.1.4.1 System enclosure**

 <p><b>Item No.: 850-825</b> IP65 enclosure; Aluminium (RAL 7032); Wx-HxD (160x100x160 mm); 9 x M12, 4 x M20</p>	 <p><b>Item No.: 850-826</b> IP65 enclosure; Aluminium (RAL 7032); Wx-HxD (240x100x160 mm); 4 x M20, 4 x M16, 14 x M12 cable grip</p>	 <p><b>Item No.: 850-827</b> IP65 enclosure; Aluminium (RAL 7032); Wx-HxD (320x100x160 mm); 4 x M20, 8 x M16, 17 x M12 cable grip</p>	 <p><b>Item No.: 850-828</b> IP65 enclosure; Aluminium (RAL 7032); Wx-HxD (480x100x160 mm); 4 x M20, 10 x M16, 35 x M12 cable grip</p>
 <p><b>Item No.: 850-826/002-000</b> IP65 enclosure; Aluminium (RAL 7035); Wx-HxD (240x100x160 mm); 4 x M20, 4 x M16, 14 x M12 cable grip</p>	 <p><b>Item No.: 850-827/002-000</b> IP65 enclosure; Aluminium (RAL 7035); Wx-HxD (320x100x160 mm); 4 x M20, 8 x M16, 17 x M12 cable grip</p>	 <p><b>Item No.: 850-828/002-000</b> IP65 enclosure; Aluminium (RAL 7035); Wx-HxD (480x100x160 mm); 4 x M20, 10 x M16, 35 x M12 cable grip</p>	 <p><b>Item No.: 850-834</b> IP65 enclosure; Polyester (RAL 7032); Wx-HxD (164x100x164 mm); 9 x M12, 4 x M20</p>
 <p><b>Item No.: 850-835</b> IP65 enclosure; Polyester (RAL 7032); Wx-HxD (244x100x164 mm); 4 x M20, 4 x M16, 14 x M12 cable grip</p>	 <p><b>Item No.: 850-836</b> IP65 enclosure; Polyester (RAL 7032); Wx-HxD (324x100x164 mm); 4 x M20, 8 x M16, 17 x M12 cable grip</p>	 <p><b>Item No.: 850-814/002-000</b> IP65 enclosure; Sheet steel (RAL 7035); Wx-HxD (200x120x200 mm); without flange plate</p>	 <p><b>Item No.: 850-815/002-000</b> IP65 enclosure; Sheet steel (RAL 7035); Wx-HxD (300x120x200 mm); without flange plate</p>

### 1.1.4.1 System enclosure



**Item No.: 850-816/002-000**

IP65 enclosure; Sheet steel (RAL 7035); Wx-HxD (400x120x200 mm); without flange plate

**Item No.: 850-817/002-000**

IP65 enclosure; Sheet steel (RAL 7035); Wx-HxD (600x120x200 mm); without flange plate