

Data Sheet | Item Number: 765-4102/100-000

8-Port IO-Link Master Class B; Profinet; DC 24 V / 2.0 A; 8xM12 connection; WideLine

<https://www.wago.com/765-4102/100-000>

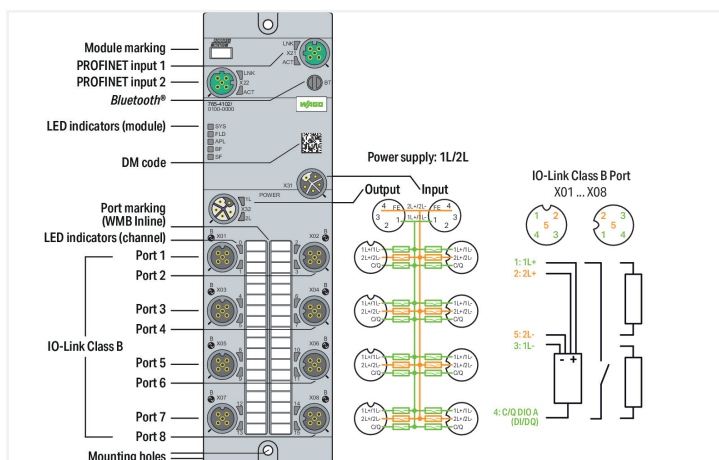

Application:

Decentralized processing of digital and IO-Link signals

The device controls IO-Link-capable digital field devices (e.g., actuators and hubs) and records digital signals from IO-Link-capable field devices (e.g., sensors and hubs) that are sent or received by a higher-level controller. The device is designed as a Class B master and offers 8 IO-Link ports or 8 digital inputs/outputs.

IO-Link:

The device has several IO-Link communication interfaces for interoperation with IO-Link devices.

The IO-Link interface enables direct access to the process and diagnostic data and allows the parameters of the connected devices to be set during operation.

The IODD can also be <https://ioddfinder.io-link.com> downloaded via the IODDfinder.

Technical data

Fieldbus

Communications	PROFINET PROFINET IO device; 2-port switch, LLDP, MRP, SNMP
Connection technology: communication/ fieldbus	2 x D-coded M12; 4-pole
Interface standard	10BASE-T/100BASE-TX; potential-free
Autonegotiation; autocrossover	Yes

Fieldbus

PROFINET IO features	PROFINET IO device; 2-port switch, LLDP, MRP, SNMP
----------------------	---

Device functions

Parameter	Input filter Output current Temperature
Diagnostics	Undervoltage; overcurrent; overload; overtemperature
Device functions	Bluetooth® OPC UA server
Radio technology	Bluetooth®: This module has an RF transmitter with the following specifications: Operating frequency: 2402 ... 2480 MHz; Maximum RF output power: <20 mW
Visualization	Android/iOS app Web server

IO-Link master

IO-Link master classification	Class B; V1.1 specification
Port-Modus	IO-Link: autoconfig, manual, tool-based DI DO
Cycle time	400 µs (min.)
Operating mode	IO-Link master, DI or DO (adjustable for pin 4 per port); Supply voltage 2L (fixed for pin 2 per port)

IO-Link ports

Number of digital inputs	8
Number of digital outputs	8
Connection technology: I/O	8 x A-coded M12; 5-pole
Signal type (voltage)	24 VDC
Input characteristic	high-side switching
Input filter	0.2 ... 20 ms
Input characteristic	Type 3, per IEC 61131-2
Output current (per channel)	2 A (typ.) for DO
Supply current per port	1L (pin 1): 1 A for IO-Link; 4 A (max.) for DIO; 2L (pin 2): 4 A (max.)

Supply (module)

Connection technology: supply	2 x L-coded M12; 5-pole
Supply voltage	24 VDC (18 ... 31.2 V); 1L/2L
Current consumption (max.)	16000 mA
Current consumption (note)	per supply line; overload- and short-cir- cuit-protected
Reverse voltage protection	Yes

Physical data

Width	60 mm / 2.362 inches
Height	30 mm / 1.181 inches
Depth	210 mm / 8.268 inches

Material data

Fire load	0 MJ
Weight	610 g
Conformity marking	CE

Environmental requirements

Ambient temperature (operation)	-25 ... +70 °C
Ambient temperature (storage)	-40 ... +80 °C
Protection type	IP67
Protection class	III per EN 61140, IEC 61140, VDE 0140-1
Pollution degree	3 (EN 60664-1)
Operating altitude	0 ... 2000 m / 0 ... 6562 ft
Relative humidity (without condensation)	95 %
Vibration resistance	5g per IEC 60068-2-6
Shock resistance	Short-term: 50g/11 ms/half-sine per IEC 60068-2-27; Long-term: 30g/6 ms/half-sine per IEC 60068-2-29
EMC immunity to interference	per EN 61000-6-2
EMC emission of interference	per EN 61000-6-4

Commercial data

PU (SPU)	1 pcs
Packaging type	Box
Country of origin	DE
GTIN	4055143949798
Customs tariff number	85371098990

Product Classification

UNSPSC	32151705
ETIM 9.0	EC001601
ETIM 10.0	EC001601
ECCN	NO US CLASSIFICATION

Environmental Product Compliance

RoHS Compliance Status	Compliant, No Exemption
SCIP notification number (Austria)	6d1ad9c1-f95d-4c14-8249-159e28231916
SCIP notification number (Belgium)	5388b1d3-f9db-4c51-b872-077bae18af07
SCIP notification number (Bulgaria)	fca0a80a-38f1-4a64-9ef2-10822ae109fa
SCIP notification number (Czech Republic)	6bee4663-25bd-40e2-8b1c-9fe19ae56536
SCIP notification number (Denmark)	e38dc57d-6ab8-4cfb-a008-376fe963f05d
SCIP notification number (Finland)	a055f1db-fe5d-4c80-a685-dcbf2ff4b043
SCIP notification number (France)	07c4e187-d4cc-4538-921b-27e445e47d66
SCIP notification number (Germany)	d0385843-01ac-4b79-b70b-10a201bea192
SCIP notification number (Hungary)	8a954bcc-af15-4622-9259-db1ff4812ce8
SCIP notification number (Italy)	6855686e-55a2-47c5-a76b-df412b67c4b6
SCIP notification number (Netherlands)	7283711d-0d9c-49f4-b90d-57207f3c2a2d
SCIP notification number (Poland)	59ed2081-7e91-4b91-a03f-43941b9fd638
SCIP notification number (Romania)	fe084e57-3f78-40c9-9f2a-2002df7edd86
SCIP notification number (Sweden)	80da011c-4c17-4690-a3c1-06fa6eb066e5

Approvals / Certificates

General approvals



Approval	Standard	Certificate Name
EAC GZO Almaty Standart	TP TC 020/2011	EAC CoC 03083
KC National Radio Research Agency	Article 58-2, Clause 3	KC R-R-W43-FB765
UL Underwriters Laboratories Inc. (ORDINARY LOCATI- ONS)	-	E175199

Declarations of conformity and manufacturer's declarations

Approval	Standard	Certificate Name
EU-Declaration of Confor- mity WAGO GmbH & Co. KG	-	-

Downloads

Environmental Product Compliance



Compliance Search

Environmental Product
Compliance
765-4102/100-000



Documentation

Manual

Cybersecurity Manual WAGO I/O System Field	4446174731 3 en-US 2025-08-04 12:00 13.08.2025	pdf 491.44 KB	
Product Manual 8-Port IO-Link Master Class B; Profinet	1562323083 6 en-US 2024-11-12 18:30 16.01.2025	pdf 10049.14 KB	

System Description

WAGO I/O System Field; General Product Infor- mation	pdf 1009.23 KB	
--	-------------------	---

Instruction Leaflet

I/O System Field packa- ge insert	V 1.4.0 25.07.2025	pdf 1083.98 KB	
--------------------------------------	-----------------------	-------------------	---

CAD/CAE-Data

CAD data



2D/3D Models 765-4102/100-000	
----------------------------------	---

CAE data

EPLAN Data Portal 765-4102/100-000	
ZUKEN Portal 765-4102/100-000	

Libraries

Device Description File

Gerätebeschreibungen PROFINET	Version 3.4 15.11.2024	zip 1533.35 KB	
Gerätebeschreibungs- dateien 765-41xx, 765-11xx, PROFINET	V1_1_0_22	zip 27.85 KB	

1 Compatible Products

1.1 Required Accessories

1.1.1 Cover

1.1.1.1 Cover



Item No.: 756-8103

M12 protective cap; for unused plugs

Item No.: 756-8102

M12 protective cap; for unused sockets

1.1.2 Marking

1.1.2.1 Marker



Item No.: 2009-115

WMB-Inline; for Smart Printer; 1500 pieces on roll; stretchable 5 - 5.2 mm; plain; snap-on type; white

1.1.2.2 Marking strip



Item No.: 2009-110

Marking strips; for Smart Printer; on reel; not stretchable; plain; snap-on type; white

1.1.3 Tool

1.1.3.1 Assembly tool



Item No.: 206-701

Torque wrench M8 and M12; Assembly kit

1.2 Optional Accessories

1.2.1 Cables and connectors

1.2.1.1 Adapter



Item No.: 756-9503/040-000

Accessories; 4-pole

Item No.: 756-9504/040-000

Accessories; 4-pole

1.2.1.2 Configurable Connector



Item No.: 756-9701/050-000
Fitted pluggable connector; 5-pole, shielded; M12 plug, straight; IDC technology



Item No.: 756-9711/050-000
Fitted pluggable connector; 5-pole, shielded; M12 socket, straight; IDC technology



Item No.: 756-9205/050-000
Fitted pluggable connector; 5-pole; M12 plug, right angle; Spring



Item No.: 756-9202/050-000
Fitted pluggable connector; 5-pole; M12 plug, straight, A-coded; Spring

1.2.1.3 Configurable Shielded Connector



Item No.: 756-9501/040-000
Accessories; M12 plug, right angle; 4-pole



Item No.: 756-9501/060-000
Fitted pluggable connector; 4-pole, shielded; M12 plug, straight, D-coded; Spring

1.2.1.4 Distribution connector



Item No.: 756-9301/050-000
Accessories; 5-pole

1.2.1.5 ETHERNET/PROFINET cable



Item No.: 756-1202/060-100
ETHERNET cable; M12D plug; angled; 4-pole; Length: 10 m



Item No.: 756-1202/060-020
ETHERNET cable; M12D plug; angled; 4-pole; Length: 2 m



Item No.: 756-1202/060-200
ETHERNET cable; M12D plug; angled; 4-pole; Length: 20 m



Item No.: 756-1202/060-050
ETHERNET cable; M12D plug; angled; 4-pole; Length: 5 m



Item No.: 756-1204/060-010
ETHERNET cable; M12D plug; angled; M12D plug; angled; 4-pole; Length: 1 m



Item No.: 756-1204/060-100
ETHERNET cable; M12D plug; angled; M12D plug; angled; 4-pole; Length: 10 m



Item No.: 756-1204/060-020
ETHERNET cable; M12D plug; angled; M12D plug; angled; 4-pole; Length: 2 m



Item No.: 756-1204/060-200
ETHERNET cable; M12D plug; angled; M12D plug; angled; 4-pole; Length: 20 m



Item No.: 756-1204/060-030
ETHERNET cable; M12D plug; angled; M12D plug; angled; 4-pole; Length: 3 m



Item No.: 756-1204/060-050
ETHERNET cable; M12D plug; angled; M12D plug; angled; 4-pole; Length: 5 m



Item No.: 756-1201/060-100
ETHERNET cable; M12D plug; straight; 4-pole; Length: 10 m



Item No.: 756-1201/060-020
ETHERNET cable; M12D plug; straight; 4-pole; Length: 2 m



Item No.: 756-1201/060-200
ETHERNET cable; M12D plug; straight; 4-pole; Length: 20 m



Item No.: 756-1201/060-050
ETHERNET cable; M12D plug; straight; 4-pole; Length: 5 m



Item No.: 756-1203/060-100
ETHERNET cable; M12D plug; straight; M12D plug; straight; 4-pole; Length: 10 m



Item No.: 756-1203/060-020
ETHERNET cable; M12D plug; straight; M12D plug; straight; 4-pole; Length: 2 m



Item No.: 756-1203/060-200
ETHERNET cable; M12D plug; straight; M12D plug; straight; 4-pole; Length: 20 m



Item No.: 756-1203/060-050
ETHERNET cable; M12D plug; straight; M12D plug; straight; 4-pole; Length: 5 m

1.2.1.6 Power cable



Item No.: 756-3504/050-100
Power cable; M12L plug; angled; 5-pole; Length: 10 m



Item No.: 756-3514/050-100
Power cable; M12L plug; angled; 5-pole; Length: 10 m



Item No.: 756-3504/050-150
Power cable; M12L plug; angled; 5-pole; Length: 15 m



Item No.: 756-3514/050-150
Power cable; M12L plug; angled; 5-pole; Length: 15 m



Item No.: 756-3504/050-020
Power cable; M12L plug; angled; 5-pole; Length: 2 m



Item No.: 756-3504/050-050
Power cable; M12L plug; angled; 5-pole; Length: 5 m













































Item No.: 756-3514/050-050
Power cable; M12L plug; angled; 5-pole; Length: 5 m



Item No.: 756-3504/050-075
Power cable; M12L plug; angled; 5-pole; Length: 7.5 m

1.2.1.6 Power cable

 Item No.: 756-3514/050-075 Power cable; M12L plug; angled; 5-pole; Length: 7.5 m	 Item No.: 756-3503/050-100 Power cable; M12L plug; straight; 5-pole; Length: 10 m	 Item No.: 756-3513/050-100 Power cable; M12L plug; straight; 5-pole; Length: 10 m	 Item No.: 756-3503/050-150 Power cable; M12L plug; straight; 5-pole; Length: 15 m
 Item No.: 756-3513/050-150 Power cable; M12L plug; straight; 5-pole; Length: 15 m	 Item No.: 756-3503/050-020 Power cable; M12L plug; straight; 5-pole; Length: 2 m	 Item No.: 756-3513/050-020 Power cable; M12L plug; straight; 5-pole; Length: 2 m	 Item No.: 756-3503/050-050 Power cable; M12L plug; straight; 5-pole; Length: 5 m
 Item No.: 756-3513/050-050 Power cable; M12L plug; straight; 5-pole; Length: 5 m	 Item No.: 756-3503/050-075 Power cable; M12L plug; straight; 5-pole; Length: 7.5 m	 Item No.: 756-3513/050-075 Power cable; M12L plug; straight; 5-pole; Length: 7.5 m	 Item No.: 756-3502/050-100 Power cable; M12L socket; angled; 5-pole; Length: 10 m
 Item No.: 756-3512/050-100 Power cable; M12L socket; angled; 5-pole; Length: 10 m	 Item No.: 756-3502/050-150 Power cable; M12L socket; angled; 5-pole; Length: 15 m	 Item No.: 756-3512/050-150 Power cable; M12L socket; angled; 5-pole; Length: 15 m	 Item No.: 756-3502/050-020 Power cable; M12L socket; angled; 5-pole; Length: 2 m
 Item No.: 756-3512/050-020 Power cable; M12L socket; angled; 5-pole; Length: 2 m	 Item No.: 756-3502/050-050 Power cable; M12L socket; angled; 5-pole; Length: 5 m	 Item No.: 756-3512/050-050 Power cable; M12L socket; angled; 5-pole; Length: 5 m	 Item No.: 756-3502/050-075 Power cable; M12L socket; angled; 5-pole; Length: 7.5 m
 Item No.: 756-3512/050-075 Power cable; M12L socket; angled; 5-pole; Length: 7.5 m	 Item No.: 756-3506/050-003 Power cable; M12L socket; angled; M12L plug; angled; 5-pole; Length: 0.3 m	 Item No.: 756-3506/050-005 Power cable; M12L socket; angled; M12L plug; angled; 5-pole; Length: 0.5 m	 Item No.: 756-3516/050-005 Power cable; M12L socket; angled; M12L plug; angled; 5-pole; Length: 0.5 m
 Item No.: 756-3506/050-010 Power cable; M12L socket; angled; M12L plug; angled; 5-pole; Length: 1 m	 Item No.: 756-3516/050-010 Power cable; M12L socket; angled; M12L plug; angled; 5-pole; Length: 1 m	 Item No.: 756-3506/050-100 Power cable; M12L socket; angled; M12L plug; angled; 5-pole; Length: 10 m	 Item No.: 756-3516/050-100 Power cable; M12L socket; angled; M12L plug; angled; 5-pole; Length: 10 m
 Item No.: 756-3506/050-150 Power cable; M12L socket; angled; M12L plug; angled; 5-pole; Length: 15 m	 Item No.: 756-3506/050-020 Power cable; M12L socket; angled; M12L plug; angled; 5-pole; Length: 2 m	 Item No.: 756-3516/050-020 Power cable; M12L socket; angled; M12L plug; angled; 5-pole; Length: 2 m	 Item No.: 756-3516/050-200 Power cable; M12L socket; angled; M12L plug; angled; 5-pole; Length: 20 m
 Item No.: 756-3516/050-400 Power cable; M12L socket; angled; M12L plug; angled; 5-pole; Length: 40 m	 Item No.: 756-3506/050-050 Power cable; M12L socket; angled; M12L plug; angled; 5-pole; Length: 5 m	 Item No.: 756-3516/050-050 Power cable; M12L socket; angled; M12L plug; angled; 5-pole; Length: 5 m	 Item No.: 756-3506/050-075 Power cable; M12L socket; angled; M12L plug; angled; 5-pole; Length: 7.5 m
 Item No.: 756-3516/050-075 Power cable; M12L socket; angled; M12L plug; angled; 5-pole; Length: 7.5 m	 Item No.: 756-3501/050-100 Power cable; M12L socket; straight; 5-pole; Length: 10 m	 Item No.: 756-3511/050-100 Power cable; M12L socket; straight; 5-pole; Length: 10 m	 Item No.: 756-3501/050-150 Power cable; M12L socket; straight; 5-pole; Length: 15 m
 Item No.: 756-3511/050-150 Power cable; M12L socket; straight; 5-pole; Length: 15 m	 Item No.: 756-3501/050-020 Power cable; M12L socket; straight; 5-pole; Length: 2 m	 Item No.: 756-3511/050-020 Power cable; M12L socket; straight; 5-pole; Length: 2 m	 Item No.: 756-3501/050-050 Power cable; M12L socket; straight; 5-pole; Length: 5 m
 Item No.: 756-3511/050-050 Power cable; M12L socket; straight; 5-pole; Length: 5 m	 Item No.: 756-3501/050-075 Power cable; M12L socket; straight; 5-pole; Length: 7.5 m	 Item No.: 756-3511/050-075 Power cable; M12L socket; straight; 5-pole; Length: 7.5 m	 Item No.: 756-3505/050-003 Power cable; M12L socket; straight; M12L plug; straight; 5-pole; Length: 0.3 m
 Item No.: 756-3505/050-005 Power cable; M12L socket; straight; M12L plug; straight; 5-pole; Length: 0.5 m	 Item No.: 756-3515/050-005 Power cable; M12L socket; straight; M12L plug; straight; 5-pole; Length: 0.5 m	 Item No.: 756-3505/050-010 Power cable; M12L socket; straight; M12L plug; straight; 5-pole; Length: 1 m	 Item No.: 756-3515/050-010 Power cable; M12L socket; straight; M12L plug; straight; 5-pole; Length: 1 m

1.2.1.6 Power cable



Item No.: 756-3505/050-100

Power cable; M12L socket; straight; M12L plug; straight; 5-pole; Length: 10 m



Item No.: 756-3515/050-100

Power cable; M12L socket; straight; M12L plug; straight; 5-pole; Length: 10 m



Item No.: 756-3505/050-150

Power cable; M12L socket; straight; M12L plug; straight; 5-pole; Length: 15 m



Item No.: 756-3505/050-020

Power cable; M12L socket; straight; M12L plug; straight; 5-pole; Length: 2 m



Item No.: 756-3515/050-020

Power cable; M12L socket; straight; M12L plug; straight; 5-pole; Length: 2 m



Item No.: 756-3515/050-200

Power cable; M12L socket; straight; M12L plug; straight; 5-pole; Length: 20 m



Item No.: 756-3515/050-300

Power cable; M12L socket; straight; M12L plug; straight; 5-pole; Length: 30 m



Item No.: 756-3515/050-400

Power cable; M12L socket; straight; M12L plug; straight; 5-pole; Length: 40 m



Item No.: 756-3505/050-050

Power cable; M12L socket; straight; M12L plug; straight; 5-pole; Length: 5 m



Item No.: 756-3515/050-050

Power cable; M12L socket; straight; M12L plug; straight; 5-pole; Length: 5 m



Item No.: 756-3505/050-075

Power cable; M12L socket; straight; M12L plug; straight; 5-pole; Length: 7.5 m



Item No.: 756-3515/050-075

Power cable; M12L socket; straight; M12L plug; straight; 5-pole; Length: 7.5 m

1.2.1.7 Sensor/actuator cable



Item No.: 756-5312/050-015

Sensor/Actuator cable; M12A plug; angled; 5-pole; Length: 1.5 m



Item No.: 756-5312/050-100

Sensor/Actuator cable; M12A plug; angled; 5-pole; Length: 10 m



Item No.: 756-5312/050-050

Sensor/Actuator cable; M12A plug; angled; 5-pole; Length: 5 m



Item No.: 756-5311/050-015

Sensor/Actuator cable; M12A plug; straight; 5-pole; Length: 1.5 m



Item No.: 756-5311/050-100

Sensor/Actuator cable; M12A plug; straight; 5-pole; Length: 10 m



Item No.: 756-5311/050-050

Sensor/Actuator cable; M12A plug; straight; 5-pole; Length: 5 m



Item No.: 756-5404/050-010

Sensor/Actuator cable; M12A socket; angled; M12A plug; angled; 5-pole; Length: 1 m



Item No.: 756-5404/050-020

Sensor/Actuator cable; M12A socket; angled; M12A plug; angled; 5-pole; Length: 2 m



Item No.: 756-5403/050-010

Sensor/Actuator cable; M12A socket; angled; M12A plug; straight; 5-pole; Length: 1 m



Item No.: 756-5403/050-020

Sensor/Actuator cable; M12A socket; angled; M12A plug; straight; 5-pole; Length: 2 m



Item No.: 756-5402/050-010

Sensor/Actuator cable; M12A socket; straight; M12A plug; angled; 5-pole; Length: 1 m



Item No.: 756-5402/050-020

Sensor/Actuator cable; M12A socket; straight; M12A plug; angled; 5-pole; Length: 2 m



Item No.: 756-5401/050-010

Sensor/Actuator cable; M12A socket; straight; M12A plug; straight; 5-pole; Length: 1 m



Item No.: 756-5401/050-020

Sensor/Actuator cable; M12A socket; straight; M12A plug; straight; 5-pole; Length: 2 m